

本系列控制器材,上部與接點座部份可分離,除二點式按鈕、及二點式照光按鈕外(IP40),全系列保護構造皆為IP65(IEC144),可防水、防油、防塵、適用於較惡劣之環境。

■ 裝配孔徑與距離

Ø22/Ø25/Ø30系列

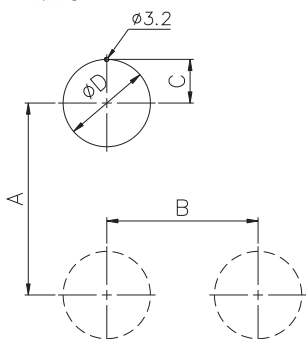

■ 上部之裝配

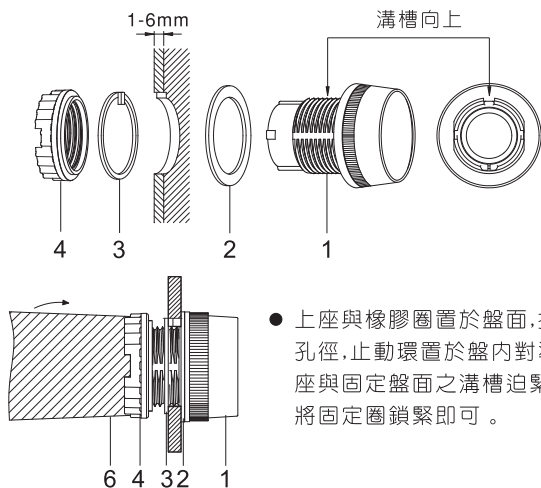

● 上座與橡膠圈置於盤面,插入孔徑,止動環置於盤內對準上座與固定盤面之溝槽迫緊,再將固定圈鎖緊即可。

1	2	3	4	5	6
上座	橡膠圈	止動環	固定圈	接點座	固定器

■ 文字與符號之標示

透明印刷紙片(種類見 P TA72)

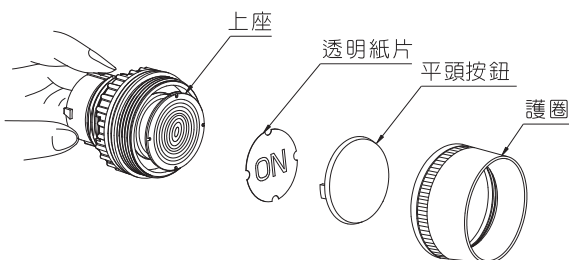

● Ø22mm/Ø25mm系列尺寸與構造完全相同,由一共用之固定圈固定之。

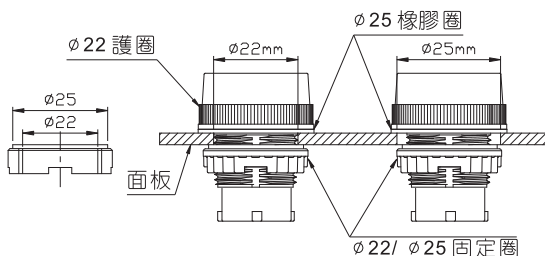

■ 尺寸說明:所有尺寸均為mm

系	列	Ø22	Ø25	Ø30
C	所有機種	11.1	12.7	15.2
D	所有機種	22.2	25.5	30.5
A	標準頭部(圓形、方形)	45min	45min	45min
	長柄選擇	50	50	50
	二點式照光按鈕	59	59	59
	附鋁銘板	45	45	50
B	標準頭部(圓形、方形)	30	30	40
	長柄選擇	45	45	50
	二點式照光按鈕	37	37	37
	附鋁銘板	31	31	40
	Ø37大頭按鈕	38	38	40

■ 接點座之裝配

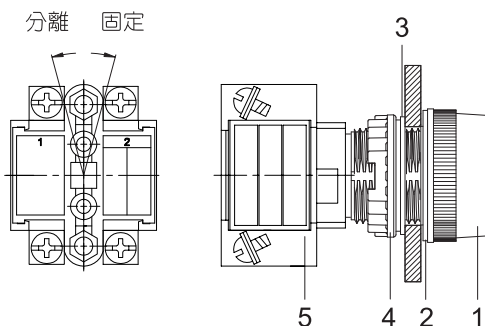

● 當上座固定後,將接點座依一大一小固定塊之相對位置,插入上座,再依CLOSE之箭頭方向旋轉,即可固定,拆卸時依OPEN之箭頭方向旋轉,即可分離。

■ 燈泡替換方法

以T2-A燈泡取卸器(見TA67)插入燈泡,順時針方向旋轉可將燈泡固定,反時針方向旋轉可將燈泡取下。

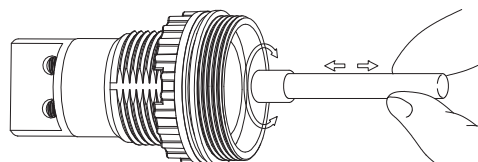

■ Ø30系列裝配方法

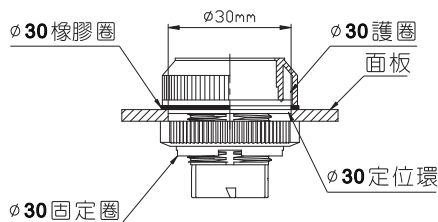

接點額定值

交流	電感負載	AC125V 6A	AC250V 4A	AC440V 2A	AC600V 1A	直 流	電感負載	DC125V 0.5A	DC250V 0.2A	DC380V 0.1A
	電阻負載	10A	6A	4A	1.5A		電阻負載	2A	0.6A	0.2A

特性

周圍溫度	-20°~+60°	
周圍濕度	45~85%RH	
接觸電阻	50mΩ以下(初期值)	
絕緣電阻	500VDC電壓下,100MΩ以上	
耐電壓	接受AC2500V之測試電壓一分鐘,無短路,破壞,燒毀等異常現象。	
壽命	機 械	按鈕開關/照光式按鈕(復歸式)為3,000,000次,其餘為500,000次
	電 氣	500,000次

標準接點座接點圖

型 式	TC-1A	TC-1B	TC-1C	TC-2A	TC-2B	TC-2C
接 點	1a	1b	1a1b	2a	2b	2a2b
接點圖						

型 式	TC-3A	TC-3B	TC-3C	TC-4A	TC-4B	TC-4C
接 點	3a	3b	3a3b	4a	4b	4a4b
接點圖						

標準接點座種類與加裝方法

短接點座接點有1a、1b、1a1b、2a、2b、五種,如需增加接點,可將短接點座拆下,換上長接點座,則接點可增加為2a2b。如需再增加接點,則在長接點後面再加一短接點座(短接點座後面無法加裝接點座)成為一長一短,接點即可增加為3a、3b、3a3b、4a、4b五種欲再增加接點,可將長接點座後面之短接點座換成長接點座,成為二長,接點即可增加為4a4b。

標準接點座裝配尺寸 (-P說明接點為保護,使用者不致誤觸電源)

TC-1A.TC-1B.TC-1C
TC-2A.TC-2B

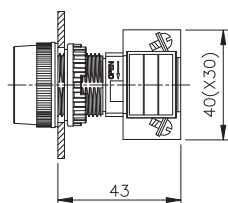

TC-3A.TC-3B.TC-3C
TC-4A.TC-4B

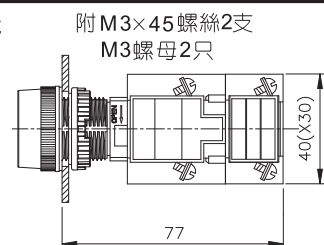

TC-2C

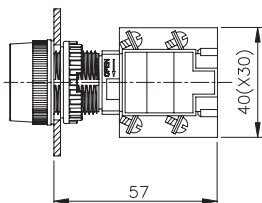
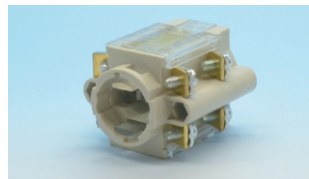

TC-4C

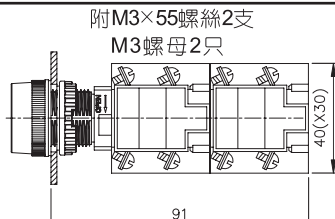
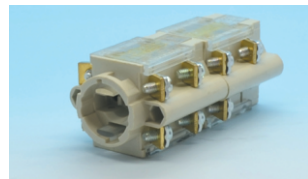

TC-1A-P.TC-1B-P.TC-1C-P
TC-2A-P.TC-2B-P

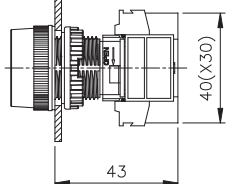

TC-2C-P

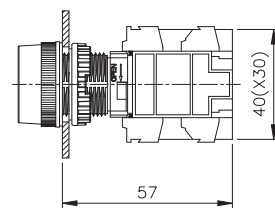

本系列開關接點座為標準接點座,其接點型式、接點圖、裝配尺寸見TA54頁

型號說明

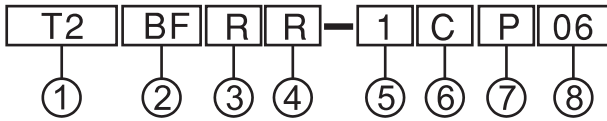

項次	代號	說明
1. 固定孔徑	T2	Ø22mm/Ø25mm
	T3	Ø30mm
2. 型式	BF	平頭
	BL	凸頭
	BM	大頭
	BA	凸頭交替式
	BB	大頭交替式
	BK	連鎖式
	BT	二點式
PB	簡單式	

- 註: 1. 簡單式上座與接點座為一體, 接點只有 1a1b 一種, 固定孔徑只有 Ø22mm/Ø25mm, 型式只有圓形。
 2. 方型系列固定孔徑只有 Ø22mm/Ø25mm。
 3. 二點式按鈕為長方形。

項次	代號	說明
3. 外形	R	圓形
	S	方形
	L	長方形
4. 顏色	R	紅
	G	綠
	Y	黃
	W	白
	B	黑
5. 接點數目	1	1組
	2	2組
	3	3組
	4	4組
6. 接點種類	A	1a
	B	1b
	C	1a1b
7. 刻字	空白	無刻字
	P	英文刻字
	M	中文刻字
8. 刻字種類	01	詳見TA72
	43	

按鈕上座部份裝配尺寸

T2BFR

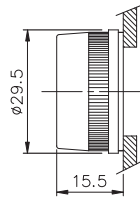

T3BFR

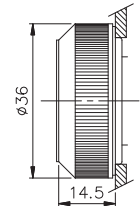

T2BLR

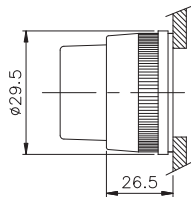

T3BLR

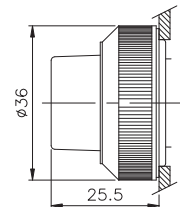

T2BMR

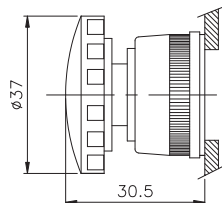

T3BMR

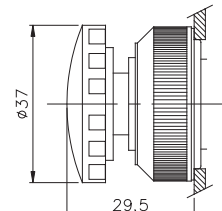

T2BAR

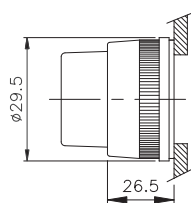

T3BAR

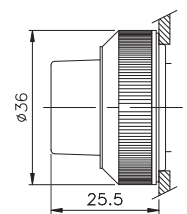

T2BBR

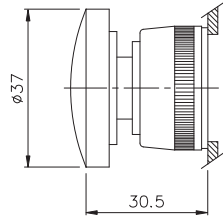
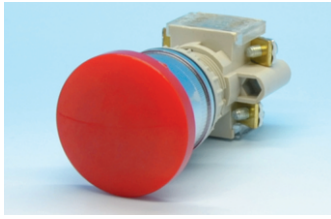

T3BBR

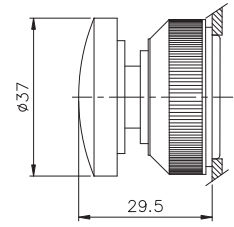
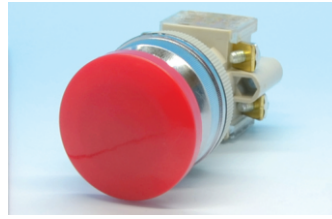

T2BKR

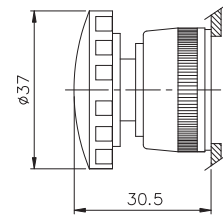
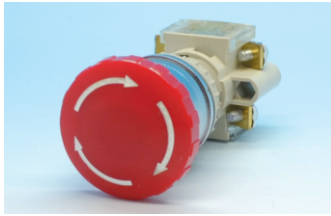

T3BKR

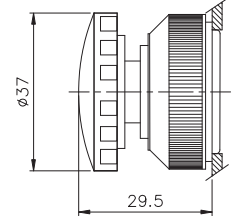

T2BTL

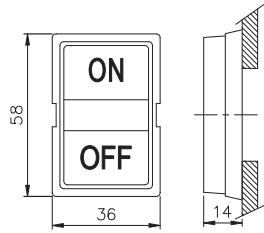

T3BTL

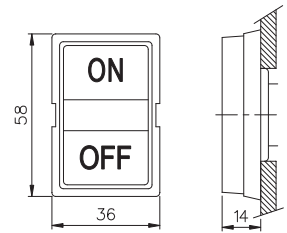
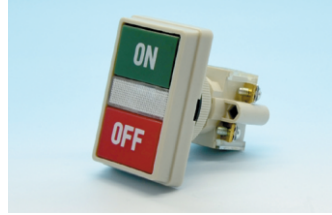

T2BFS

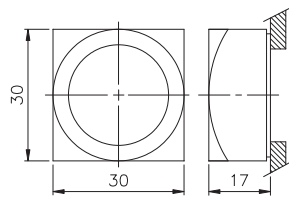
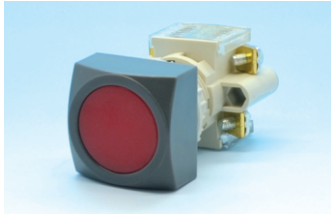

T2BLS

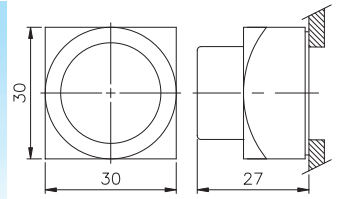
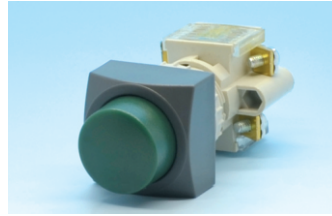

T2BMS

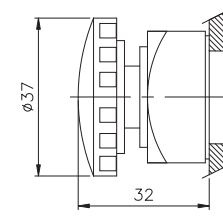
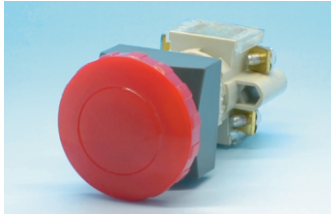

T2BAS

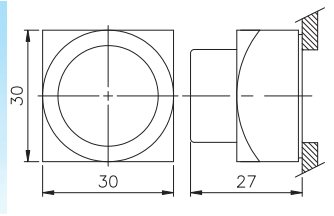
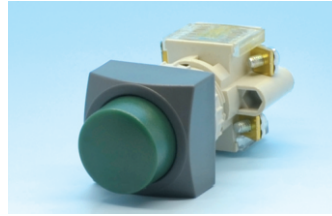

T2BBS

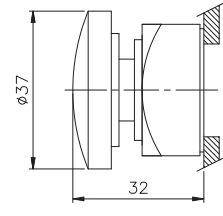
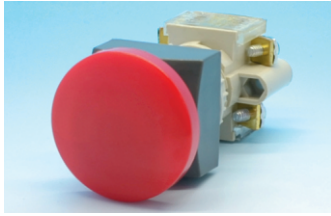

T2BKS

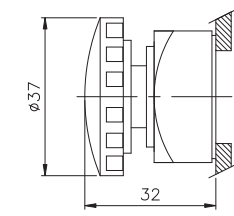
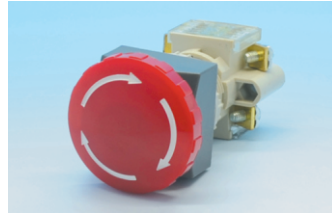

T2PB

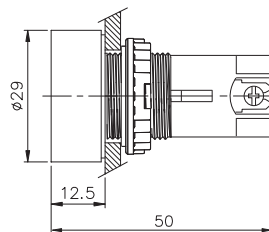

型號說明

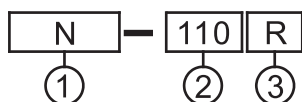

燈泡規格 (含照光式與指示燈)

項次	代號	說明
1. 燈泡種類	I	鎢絲燈泡(無顏色)
	N	霓虹燈泡
	L	LED燈泡
2. 電壓	6	6V AC/DC
	12	12V AC/DC
	18	18V AC/DC
	24	24V AC/DC
	30	30V AC/DC
	110	110V AC
	220	220V AC
3. 顏色	R	紅
	G	綠
	O	橙
	W	白
	BL	藍

燈泡種類	額定電壓	額定電流
鎢絲燈泡	6V AC/DC	150mA
	12V AC/DC	100mA
	18V AC/DC	66mA
	24V AC/DC	50mA
	30V AC/DC	40mA
霓虹燈泡	110V AC	1.3mA
	220V AC	2.2mA
	380V AC	1.15mA
	440V AC	1.4mA
LED燈泡	6V AC/DC	9~13mA
	12V AC/DC	9~13mA
	24V AC/DC	8~13mA
	30V AC/DC	8~13mA
	110V AC	3~5mA
	220V AC	3~5mA

燈泡全部為BA9S-11X28mm(Ø9)，最大功率1.2W

鎢絲燈泡

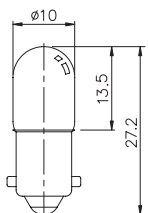

霓虹燈泡

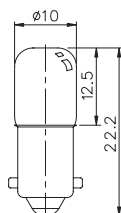

LED燈泡

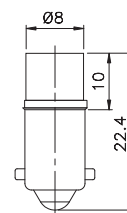

型號說明

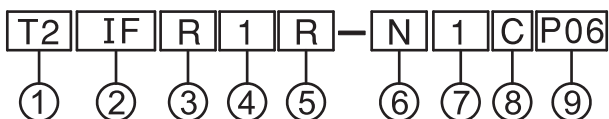

項次	代號	說明
1. 固定孔徑	T2 T3	Ø22mm/Ø25mm Ø30mm
2. 型式	IF	平頭
	IL	凸頭
	IM	大頭
	IA	凸頭交替式
	IB	大頭交替式
	IK IT	連鎖式 二點式
3. 外形	R	圓形
	S	方形
	L	長方形

註:1. 方型系列固定孔徑只有Ø22mm/Ø25mm。

2. 二點式照光按鈕為長方形。

項次	代號	說明
4. 電壓	1	110VAC (霓虹、LED燈泡)
	2	220VAC (霓虹、LED燈泡)
	3	380VAC (霓虹燈泡)
	4	440VAC (霓虹燈泡)
	5	6V (鎢絲、LED燈泡)
	6	18V (鎢絲燈泡)
	7	24V (鎢絲、LED燈泡)
	8	30V (鎢絲、LED燈泡)
	9	12V (鎢絲、LED燈泡)
5. 顏色	R G O W BL	紅 綠 橙 白 藍
6. 燈泡種類	I N L	鎢絲燈泡 霓虹燈泡 LED燈泡
7. 接點數目	1 2 3	1組 2組 3組
8. 接點種類	A B C	1a 1b 1a1b
9. 刻字種類	空白 P01~P43 M01~M22	無刻字 英文刻字 詳見 TA 72 TPP 中文刻字 詳見 TA 72 TPM

直接式照光按鈕上座裝配尺寸

T2IFR

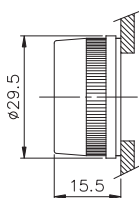

T3IFR

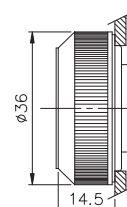

T2ILR

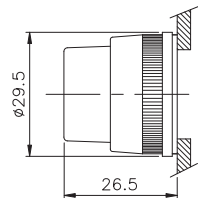

T3ILR

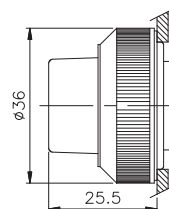

T2IMR

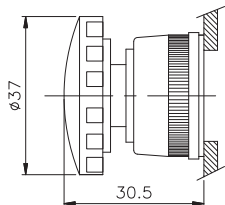

T3IMR

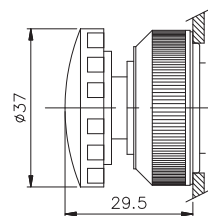

T2IAR

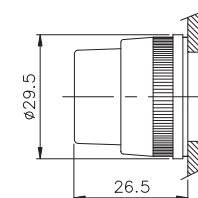

T3IAR

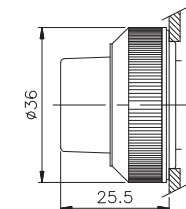

T2IBR

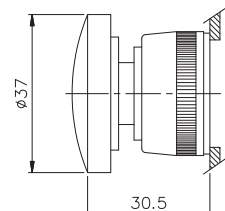

T3IBR

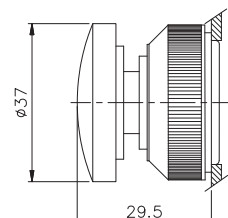

T2IKR

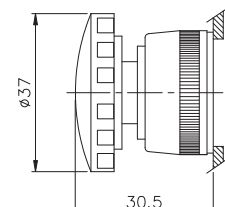

T3IKR

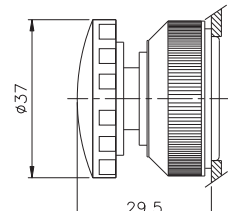

T2ITL

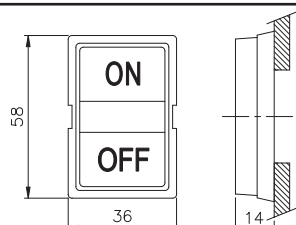

T3ITL

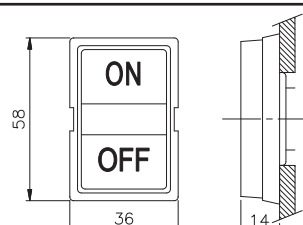

T2IFS

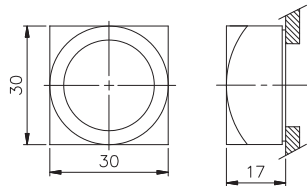

T2ILS

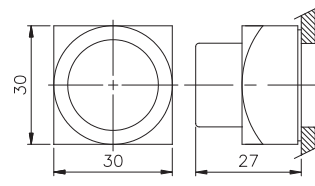
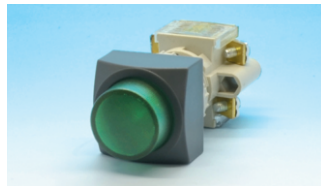

T2IMS

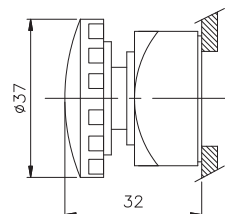

T2IAS

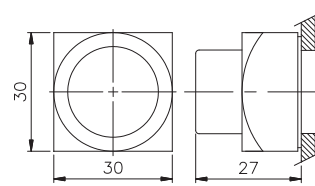
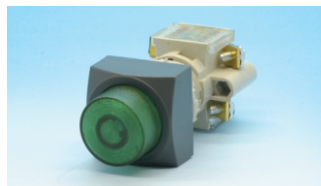

T2IBS

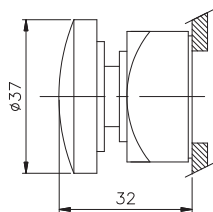
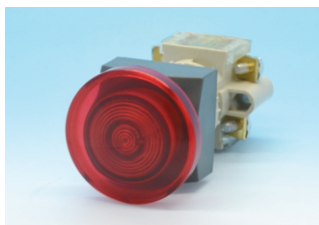

T2IKS

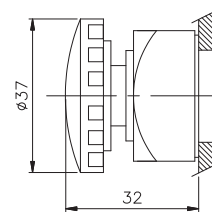

直接式照光接點座接點圖

型式	TC-I1A	TC-I1B	TC-I1C	TC-I2A
接點	1a	1b	1a1b	2a
接點圖				

型式	TC-I2C	TC-I3A	TC-I3B	TC-I4A	TC-I3C
接點	2a2b	3a	3b	4a	3a3b
接點圖					

直接式照光接點座種類與加裝方法

短接點座接點有1a、1b二種，長接點座有1a1b、2a二種，如需增加接點，可在長接點座後面加一短接點座（短接點座後面無法加裝接點座），成為一長一短，接點即可增加為2b、2a2b、3a、3b、4a五種，欲再增加接點，可將長接點座後面之短接點座換成長接點座，成為二長，接點即可增加為3a3b。

直接式照光接點座裝配尺寸（-P說明接點為保護，使用者不致誤觸電源）

TC-I1A.TC-I1B

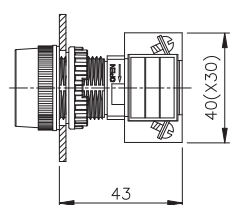
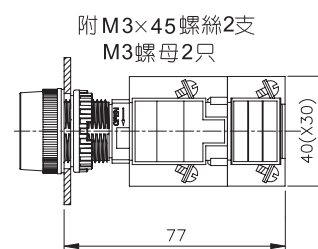
 TC-I3A.TC-I3B
TC-I2C.TC-I4A

TC-I1C.TC-I2A

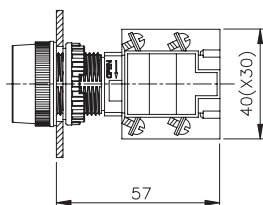

TC-I3C

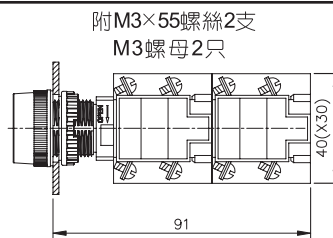
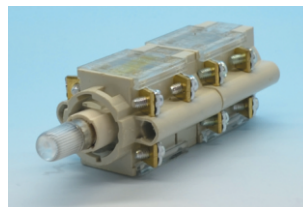

TC-I1A-P.TC-I1B-P

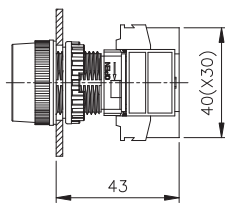

TC-I1C-P.TC-I2A-P

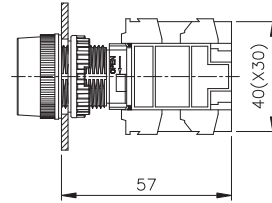

tend Ø22/Ø25/Ø30照光式按鈕開關

T2

本系列開關為附變壓器式，二次電壓全部為5V，一律使用TS9-5(6V)燈泡，見TA57頁，接點座採用標準接點座，裝配尺寸見TA54頁。

型號說明

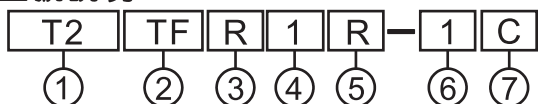

項次	代號	說明
1. 固定孔徑	T2	Ø22mm/Ø25mm
	T3	Ø30mm
2. 型 式	TF	平頭
	TL	凸頭
	TM	大頭
	TA	凸頭交替式
	TB	大頭交替式
	TK	連鎖式
	TT	二點式

項次	代號	說明
3. 外 形	R	圓形
	S	方形
	L	長方形
4. 電 壓 (50~60HZ)	1	110/5VAC
	2	220/5VAC
5. 顏 色	R	紅
	G	綠
	O	橙
	W	白
6. 接點數目	1	1組
	2	2組
7. 接點種類	A	1a
	B	1b
	C	1a1b

照光式接點座種類及加裝方法

長短接點座同標準接點座，將變壓器座拆下後，其接點座之加裝方法同標準接點座，見TA54

註:1. 方形系列固定孔徑只有Ø22mm/Ø25mm。

2. 二點式照光按鈕為長方形。

3. 照光式按鈕開關電壓只有110/5VAC, 220/5VAC二種。

照光式按鈕上座裝配尺寸

T2TFR

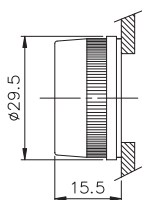

T3TFR

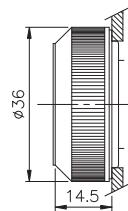

T2TLR

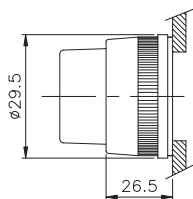

T3TLR

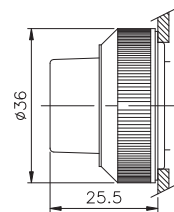

T2TMR

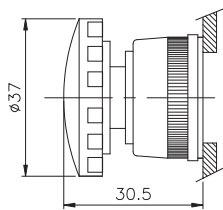

T3TMR

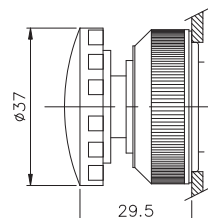

T2TAR

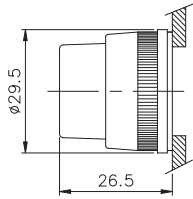
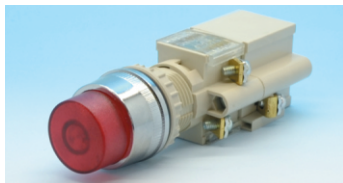

T3TAR

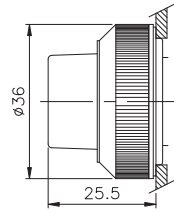

T2TBR

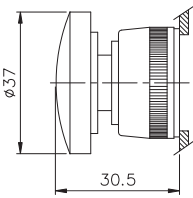

T3TBR

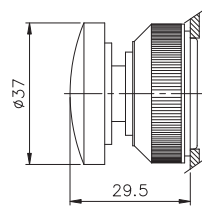

T2TKR

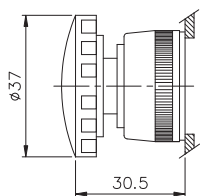

T3TKR

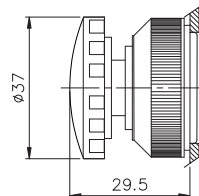

T2TTL

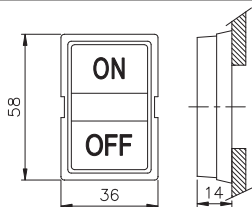

T3TTL

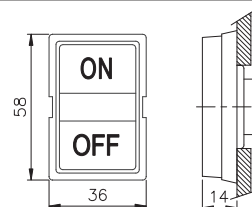

T2TFS

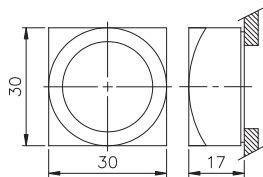

T2TLS

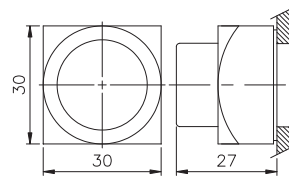

T2TMS

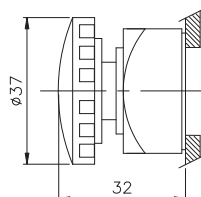
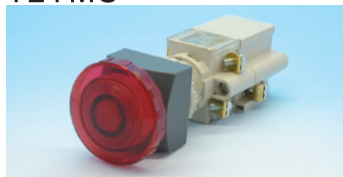

T2TAS

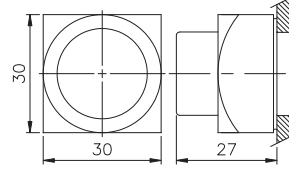
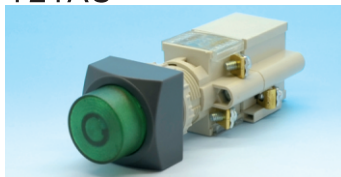

T2TBS

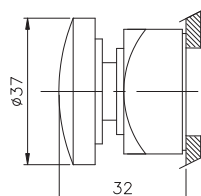
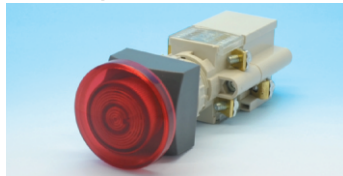

T2TKS

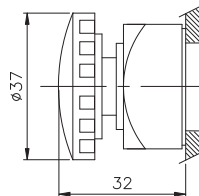
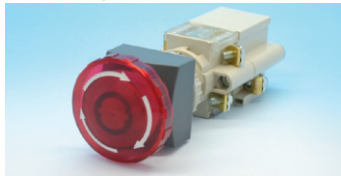

照光式接點座附變壓器

型式	TC-T1A	TC-T1B	TC-T1C	TC-T2A	TC-T2B	TC-T2C
接點	1a	1b	1a1b	2a	2b	2a2b
接點圖						

照光式接點座附變壓器裝配尺寸 (-P說明接點為保護,使用者不致誤觸電源)

TC-T1A TC-T1B TC-T1C
TC-T2A TC-T2B

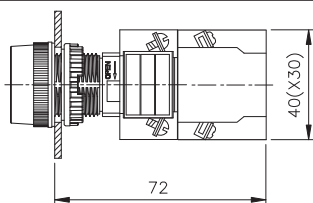

TC-T2C

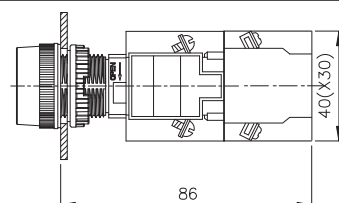

TC-T1A-P. TC-T1B-P. TC-T1C-P
TC-T2A-P. TC-T2B-P

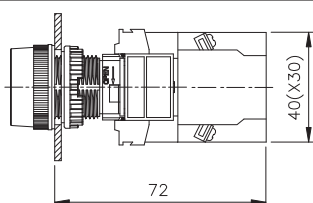
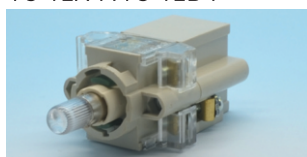

TC-T2C-P

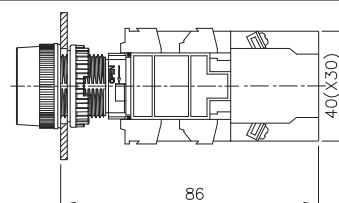
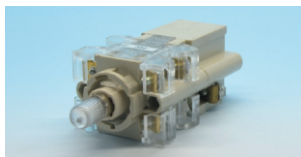

tend Ø22/Ø25/Ø30選擇開關

T2

本系列開關之接點座採用標準接點座，裝配尺寸見TA54頁

型號說明

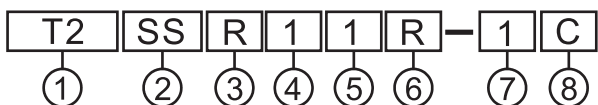

項次	代號	說明
1. 固定孔徑	T2 T3	Ø22mm/Ø25mm Ø30mm
2. 型式	SS SH KS	標準選擇 長柄選擇 鑰匙選擇
3. 外形	R S	圓形 方形
4. 動作方式	1	二段45°
	2	二段90°
	3	二段45復歸
	4	三段45×2
	5	三段45×2右邊復歸
	6	三段45×2左邊復歸
	7	三段45×2二邊復歸

項次	代號	說明	
5. 鑰匙抽出位置	1	二段	0、1皆可抽出
	2		0可抽出
	3		1可抽出
	4	三段	0、1、2皆可抽出
	5		0可抽出
6. 顏色	R G B	紅 綠 黑	
7. 接點數目	1 2 3 4	1組 2組 3組 4組	
8. 接點種類	A B C	二段	三段
		1a	—
		1b	—
		1a1b	1a 0 1a

選擇上座部份裝配尺寸

T2SSR 	T3SSR
T2SHR 	T3SHR
T2KSR 	T3KSR
T2SSS 	T2SHS

T2KSS

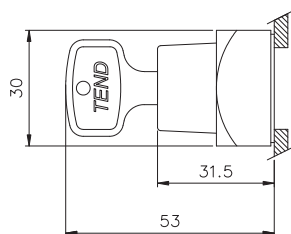
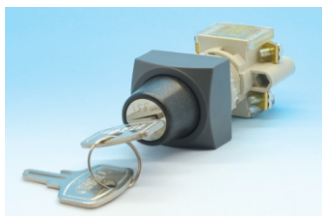

選擇開關二段接點圖

型 式	TC-1A	TC-1B	TC-1C2	TC-2A	TC-2B	TC-2C2																																																						
接 點	1a	1b	1a1b	2a	2b	2a2b																																																						
接點圖	<table border="1"> <tr> <td>接 點</td> <td>0</td> <td>1</td> </tr> <tr> <td>23-24</td> <td></td> <td>X</td> </tr> </table>	接 點	0	1	23-24		X	<table border="1"> <tr> <td>接 點</td> <td>0</td> <td>1</td> </tr> <tr> <td>11-12</td> <td>X</td> <td></td> </tr> </table>	接 點	0	1	11-12	X		<table border="1"> <tr> <td>接 點</td> <td>0</td> <td>1</td> </tr> <tr> <td>11-12</td> <td>X</td> <td></td> </tr> <tr> <td>23-24</td> <td></td> <td>X</td> </tr> </table>	接 點	0	1	11-12	X		23-24		X	<table border="1"> <tr> <td>接 點</td> <td>0</td> <td>1</td> </tr> <tr> <td>13-14</td> <td></td> <td>X</td> </tr> <tr> <td>23-24</td> <td></td> <td>X</td> </tr> </table>	接 點	0	1	13-14		X	23-24		X	<table border="1"> <tr> <td>接 點</td> <td>0</td> <td>1</td> </tr> <tr> <td>11-12</td> <td>X</td> <td></td> </tr> <tr> <td>21-22</td> <td>X</td> <td></td> </tr> </table>	接 點	0	1	11-12	X		21-22	X		<table border="1"> <tr> <td>接 點</td> <td>0</td> <td>1</td> </tr> <tr> <td>11-12</td> <td>X</td> <td></td> </tr> <tr> <td>13-14</td> <td></td> <td>X</td> </tr> <tr> <td>21-22</td> <td>X</td> <td></td> </tr> <tr> <td>23-24</td> <td></td> <td>X</td> </tr> </table>	接 點	0	1	11-12	X		13-14		X	21-22	X		23-24		X
接 點	0	1																																																										
23-24		X																																																										
接 點	0	1																																																										
11-12	X																																																											
接 點	0	1																																																										
11-12	X																																																											
23-24		X																																																										
接 點	0	1																																																										
13-14		X																																																										
23-24		X																																																										
接 點	0	1																																																										
11-12	X																																																											
21-22	X																																																											
接 點	0	1																																																										
11-12	X																																																											
13-14		X																																																										
21-22	X																																																											
23-24		X																																																										

選擇開關三段接點圖

型 式	TC-1C3	TC-2C3																																
接 點	1a 0 1a	2a 0 2a																																
接點圖	<table border="1"> <tr> <td>接 點</td> <td>1</td> <td>0</td> <td>2</td> </tr> <tr> <td>13-14</td> <td>X</td> <td></td> <td></td> </tr> <tr> <td>23-24</td> <td></td> <td></td> <td>X</td> </tr> </table>	接 點	1	0	2	13-14	X			23-24			X	<table border="1"> <tr> <td>接 點</td> <td>1</td> <td>0</td> <td>2</td> </tr> <tr> <td>13-14</td> <td>X</td> <td></td> <td></td> </tr> <tr> <td>13-14</td> <td>X</td> <td></td> <td></td> </tr> <tr> <td>23-24</td> <td></td> <td></td> <td>X</td> </tr> <tr> <td>23-24</td> <td></td> <td></td> <td>X</td> </tr> </table>	接 點	1	0	2	13-14	X			13-14	X			23-24			X	23-24			X
接 點	1	0	2																															
13-14	X																																	
23-24			X																															
接 點	1	0	2																															
13-14	X																																	
13-14	X																																	
23-24			X																															
23-24			X																															

tend Ø22/Ø25/Ø30直接式照光選擇開關

本系列開關之接點座採用直接式照光接點座，裝配尺寸見TA59頁，燈泡種類與規格同直接式照光按鈕開關，見TA57頁。

型號說明

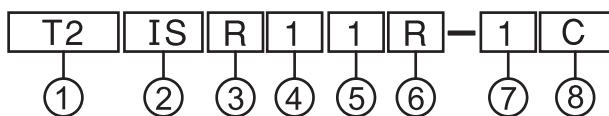

項 次	代 號	說 明
1. 固定孔徑	T2 T3	Ø22mm/Ø25mm Ø30mm
2. 型 式	IS IH	標準選擇 長柄選擇
3. 外 形	R S	圓 形 方 形
4. 動作方式	1	二段45°
	2	二段90°
	3	二段45°復歸
	4	三段45°×2
	5	三段45°×2右邊復歸
	6	三段45°×2左邊復歸
	7	三段45°×2二邊復歸

項 次	代 號	說 明	
5. 電 壓	1	110VAC (霓虹燈泡)	
	2	220VAC (霓虹燈泡)	
	3	380VAC (霓虹燈泡)	
	4	440VAC (霓虹燈泡)	
	5	6V (鎢絲燈泡)	
	6	18V (鎢絲燈泡)	
	7	24V (鎢絲燈泡)	
	8	30V (鎢絲燈泡)	
	9	12V (鎢絲燈泡)	
6. 顏 色	R	紅	
	G	綠	
	O	橙	
	W BL	白 藍	
7. 接點數目	1	1組	
	2	2組	
	3	3組	
8. 接點種類	A	二段	三段
		1a	——
	B	1b	——
		C	1a1b

註：方形系列固定孔徑只有Ø22mm/ Ø25mm。

直接式照光選擇上座部份裝配尺寸

T2ISR

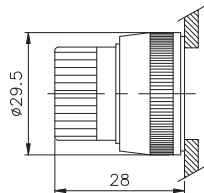

T3ISR

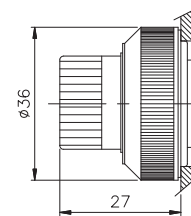
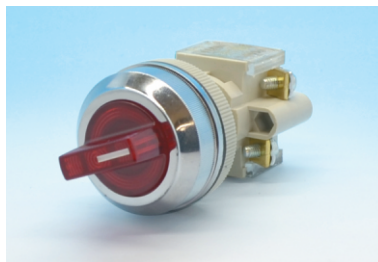

T2IHR

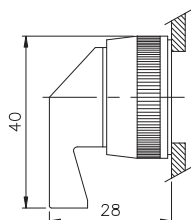

T3IHR

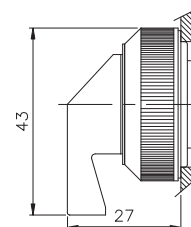

T2ISS

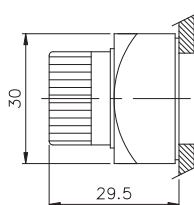
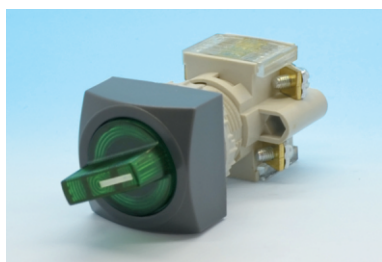

T2IHS

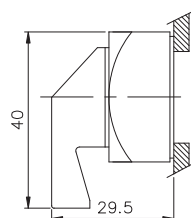
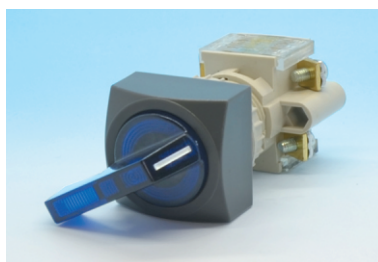

直接式照光選擇開關二段接點圖

型 式	TC-I1A	TC-I1B	TC-I1C2	TC-I2A	TC-I2B	TC-I2C2																																																						
接 點	1a	1b	1a1b	2a	2b	2a2b																																																						
接點圖																																																												
	<table border="1"> <tr><td>接 點</td><td>0</td><td>1</td></tr> <tr><td>23-24</td><td></td><td>X</td></tr> </table>	接 點	0	1	23-24		X	<table border="1"> <tr><td>接 點</td><td>0</td><td>1</td></tr> <tr><td>11-12</td><td>X</td><td></td></tr> </table>	接 點	0	1	11-12	X		<table border="1"> <tr><td>接 點</td><td>0</td><td>1</td></tr> <tr><td>11-12</td><td>X</td><td></td></tr> <tr><td>23-24</td><td></td><td>X</td></tr> </table>	接 點	0	1	11-12	X		23-24		X	<table border="1"> <tr><td>接 點</td><td>0</td><td>1</td></tr> <tr><td>13-14</td><td></td><td>X</td></tr> <tr><td>23-24</td><td></td><td>X</td></tr> </table>	接 點	0	1	13-14		X	23-24		X	<table border="1"> <tr><td>接 點</td><td>0</td><td>1</td></tr> <tr><td>11-12</td><td>X</td><td></td></tr> <tr><td>21-22</td><td>X</td><td></td></tr> </table>	接 點	0	1	11-12	X		21-22	X		<table border="1"> <tr><td>接 點</td><td>0</td><td>1</td></tr> <tr><td>11-12</td><td>X</td><td></td></tr> <tr><td>13-14</td><td></td><td>X</td></tr> <tr><td>21-22</td><td>X</td><td></td></tr> <tr><td>23-24</td><td></td><td>X</td></tr> </table>	接 點	0	1	11-12	X		13-14		X	21-22	X		23-24		X
接 點	0	1																																																										
23-24		X																																																										
接 點	0	1																																																										
11-12	X																																																											
接 點	0	1																																																										
11-12	X																																																											
23-24		X																																																										
接 點	0	1																																																										
13-14		X																																																										
23-24		X																																																										
接 點	0	1																																																										
11-12	X																																																											
21-22	X																																																											
接 點	0	1																																																										
11-12	X																																																											
13-14		X																																																										
21-22	X																																																											
23-24		X																																																										

直接式照光選擇開關三段接點圖

型 式	TC-I1C3	TC-I2C3																																
接 點	1a 0 1a	2a 0 2a																																
接點圖	<table border="1"> <tr><td>接 點</td><td>1</td><td>0</td><td>2</td></tr> <tr><td>13-14</td><td>X</td><td></td><td></td></tr> <tr><td>23-24</td><td></td><td></td><td>X</td></tr> </table>	接 點	1	0	2	13-14	X			23-24			X	<table border="1"> <tr><td>接 點</td><td>1</td><td>0</td><td>2</td></tr> <tr><td>13-14</td><td>X</td><td></td><td></td></tr> <tr><td>13-14</td><td>X</td><td></td><td></td></tr> <tr><td>23-24</td><td></td><td></td><td>X</td></tr> <tr><td>23-24</td><td></td><td></td><td>X</td></tr> </table>	接 點	1	0	2	13-14	X			13-14	X			23-24			X	23-24			X
接 點	1	0	2																															
13-14	X																																	
23-24			X																															
接 點	1	0	2																															
13-14	X																																	
13-14	X																																	
23-24			X																															
23-24			X																															

tend Ø22/Ø25/Ø30照光式選擇開關

T2

本系列開關為附變壓器式，二次電壓全部為5V，一律使用TS9-5(6V)燈泡，見TA57頁，接點座採用標準接點座，裝配尺寸見TA54頁。

型號說明

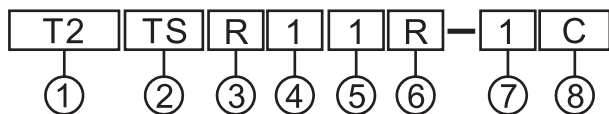

項次	代號	說明
1. 固定孔徑	T2 T3	Ø22mm/Ø25mm Ø30mm
2. 型式	TS TH	標準選擇 長柄選擇
3. 外形	R S	圓形 方形
4. 動作方式	1	二段45°
	2	二段90°
	3	二段45復歸
	4	三段45°×2
	5	三段45°×2右邊復歸
	6	三段45°×2左邊復歸
	7	三段45°×2二邊復歸

項次	代號	說明	
5. 電壓 (50~60HZ)	1	110/5VAC	
	2	220/5VAC	
6. 顏色	R	紅	
	G	綠	
	O	橙	
	W BL	白 藍	
7. 接點數目	1	1組	
	2	2組	
8. 接點種類	A	二段	三段
		1a	——
	B	1b	——
		C	1a1b

註：方形系列固定孔徑只有Ø22mm/Ø25mm。

照光式選擇開關上座部份裝配尺寸

T2TSR

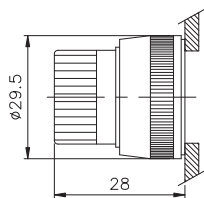
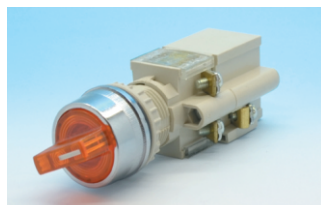

T3TSR

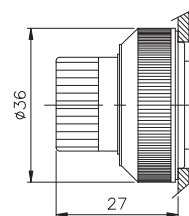
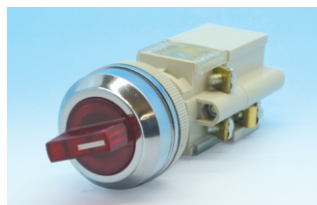

T2THR

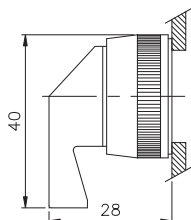

T3THR

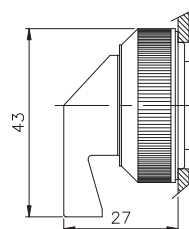

T2TSS

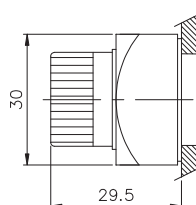
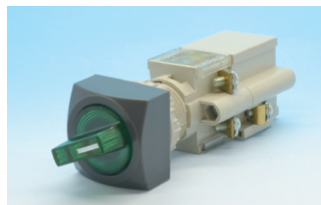

T2THS

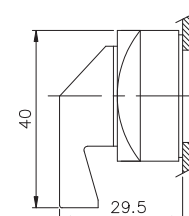
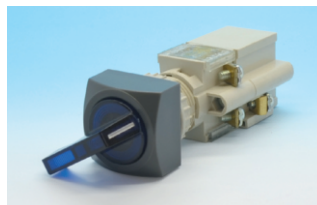

照光式選擇開關二段接點圖

型式	TC-T1A	TC-T1B	TC-T1C2	TC-T2A	TC-T2B	TC-T2C2																																																						
接點	1a	1b	1a1b	2a	2b	2a2b																																																						
接點圖																																																												
	<table border="1"> <tr><td>接點</td><td>0</td><td>1</td></tr> <tr><td>23-24</td><td></td><td>X</td></tr> </table>	接點	0	1	23-24		X	<table border="1"> <tr><td>接點</td><td>0</td><td>1</td></tr> <tr><td>11-12</td><td>X</td><td></td></tr> </table>	接點	0	1	11-12	X		<table border="1"> <tr><td>接點</td><td>0</td><td>1</td></tr> <tr><td>11-12</td><td>X</td><td></td></tr> <tr><td>23-24</td><td></td><td>X</td></tr> </table>	接點	0	1	11-12	X		23-24		X	<table border="1"> <tr><td>接點</td><td>0</td><td>1</td></tr> <tr><td>13-14</td><td></td><td>X</td></tr> <tr><td>23-24</td><td></td><td>X</td></tr> </table>	接點	0	1	13-14		X	23-24		X	<table border="1"> <tr><td>接點</td><td>0</td><td>1</td></tr> <tr><td>11-12</td><td>X</td><td></td></tr> <tr><td>21-22</td><td>X</td><td></td></tr> </table>	接點	0	1	11-12	X		21-22	X		<table border="1"> <tr><td>接點</td><td>0</td><td>1</td></tr> <tr><td>11-12</td><td>X</td><td></td></tr> <tr><td>13-14</td><td></td><td>X</td></tr> <tr><td>21-22</td><td>X</td><td></td></tr> <tr><td>23-24</td><td></td><td>X</td></tr> </table>	接點	0	1	11-12	X		13-14		X	21-22	X		23-24		X
接點	0	1																																																										
23-24		X																																																										
接點	0	1																																																										
11-12	X																																																											
接點	0	1																																																										
11-12	X																																																											
23-24		X																																																										
接點	0	1																																																										
13-14		X																																																										
23-24		X																																																										
接點	0	1																																																										
11-12	X																																																											
21-22	X																																																											
接點	0	1																																																										
11-12	X																																																											
13-14		X																																																										
21-22	X																																																											
23-24		X																																																										

照光式選擇開關三段接點圖

型式	TC-T1C3	TC-T2C3																																
接點	1a01a	2a02a																																
接點圖	<table border="1"> <tr><td>接點</td><td>0</td><td>1</td><td>2</td></tr> <tr><td>13-14</td><td>X</td><td></td><td></td></tr> <tr><td>23-24</td><td></td><td></td><td>X</td></tr> </table>	接點	0	1	2	13-14	X			23-24			X	<table border="1"> <tr><td>接點</td><td>0</td><td>1</td><td>2</td></tr> <tr><td>13-14</td><td>X</td><td></td><td></td></tr> <tr><td>13-14</td><td>X</td><td></td><td></td></tr> <tr><td>23-24</td><td></td><td></td><td>X</td></tr> <tr><td>23-24</td><td></td><td></td><td>X</td></tr> </table>	接點	0	1	2	13-14	X			13-14	X			23-24			X	23-24			X
接點	0	1	2																															
13-14	X																																	
23-24			X																															
接點	0	1	2																															
13-14	X																																	
13-14	X																																	
23-24			X																															
23-24			X																															

tend Ø22/Ø25/Ø30直接式指示燈

本系列所用燈泡種類與規格,同直接式照光按鈕開關,見TA57頁。

型號說明

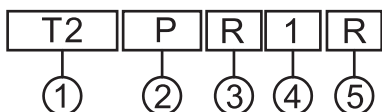

項次	代號	說明
1.固定孔徑	T2	Ø22mm/Ø25mm
	T3	Ø30mm
2.型式	P	直接式
	L	簡單式(接線螺絲在後)
	N	簡單式(接線螺絲在二側)
3.外形	R	圓形
	S	方形

項次	代號	說明
4.電壓	1	110VAC (霓虹燈泡)
	2	220VAC (霓虹燈泡)
	3	380VAC (霓虹燈泡)
	4	440VAC (霓虹燈泡)
	5	6V (鎢絲燈泡)
	6	18V (鎢絲燈泡)
	7	24V (鎢絲燈泡)
	8	30V (鎢絲燈泡)
	9	12V (鎢絲燈泡)
5.顏色	R	紅
	G	綠
	O	橙
	W	白
	BL	藍

註：1.簡單式指示燈上下座為一體,不可分離。
2.方形系列固定孔徑只有Ø22mm/Ø25mm。

直接式指示燈裝配尺寸

T2PR

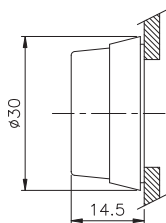

T3PR

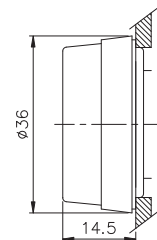

T2LR

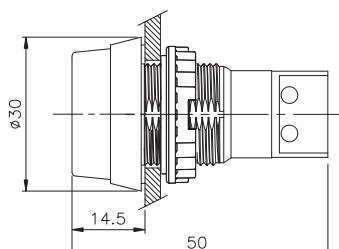

T3LR

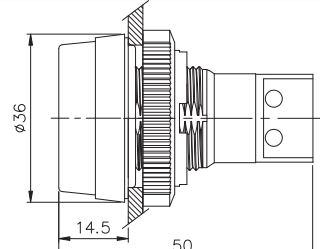

T2NR

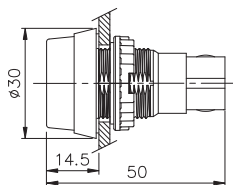

T3NR

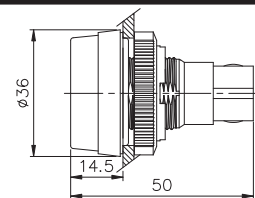

T2PS

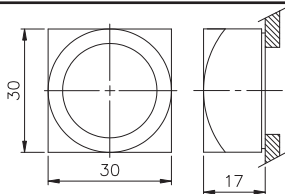

T2LS

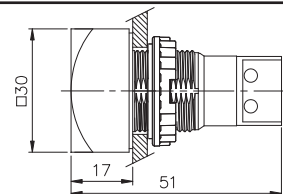

T2NS

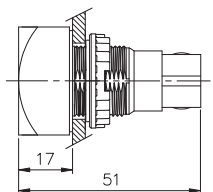

直接式指示燈電源座

TPS-1

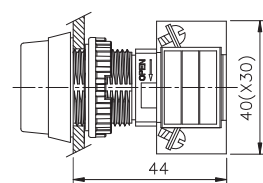
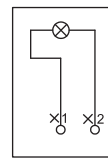

tend Ø22/Ø25/Ø30 指示燈

本系列指示燈為附變壓器式，二次電壓全部為5V，一律使用TS9-5(6V)燈泡，見TA57頁。

型號說明

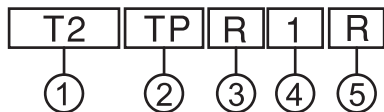

項次	代號	說明
1. 固定孔徑	T2 T3	Ø22mm/Ø25mm Ø30mm
2. 型式	TP	變壓器式

項次	代號	說明
3. 外形	R S	圓形 方形
4. 電壓	1 2	110/5 VAC 220/5 VAC
5. 顏色	R G O W BL	紅 綠 橙 白 藍

指示燈裝配尺寸

T2TPR

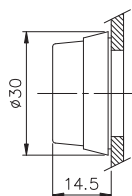

T3TPR

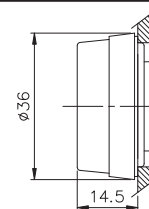

T2TPS

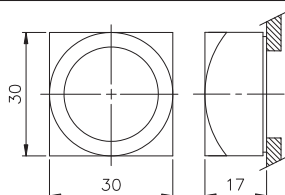

燈泡取卸器 T2-A

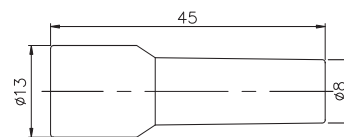

指示燈電源座

TPS-2

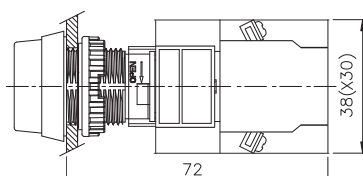
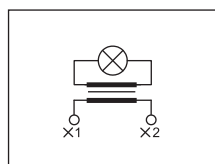

本系列開關接點座為標準接點座,其接點型式,接點圖,裝配尺寸見TA54頁。

型號說明

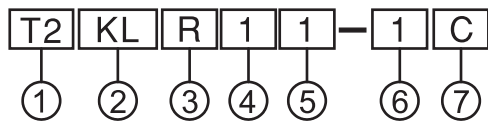

項次	代號	說明
1. 固定孔徑	T2	Ø22mm/Ø25mm
	T3	Ø30mm
2. 型式	KL	凸頭
	KM	大頭
3. 外形	R	圓形
	S	方形

註：1. 方形系列固定孔徑只有Ø22mm/Ø25mm。

2. 動作方式第四項鑰匙連鎖復歸式,其鑰匙抽出位置代號為空白。

3. 鑰匙切換方式皆為二段式 $0\ 90^\circ\ 1$ 。

項次	代號	說明
4. 動作方式	1	鑰匙復歸式 ① 靜止時不能按下。 ② 鑰匙右轉時,可按下為復歸式按鈕。
		鑰匙連鎖式 ① 靜止時,可按下為連鎖式按鈕。 ② 鑰匙右轉時,按鈕即復歸。
	3	鑰匙固定式 ① 靜止時,不能按下。 ② 將鑰匙右轉可按下,再向左轉可固定。 ③ 將鑰匙右轉可復歸。
		鑰匙連鎖復歸式 ① 鑰匙靜止時,可按下為連鎖式,鑰匙向右轉可復歸。 ② 鑰匙向右轉可抽出,成為復歸式按鈕。
5. 鑰匙抽出位置	1	靜止及右轉時皆可抽出
	2	靜止才可抽出
6. 接點數目	1	1組
	2	2組
	3	3組
7. 接點種類	A	1a
	B	1b
	C	1a1b

鑰匙按鈕上座部份裝配尺寸

T2KLR

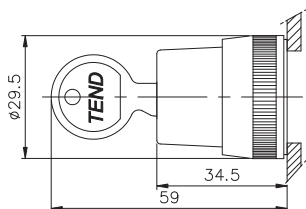

T3KLR

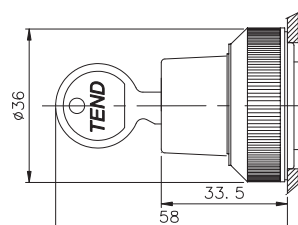

T2KMR

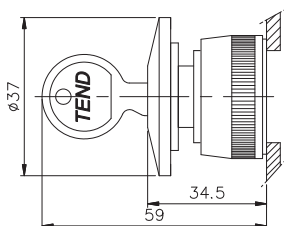

T3KMR

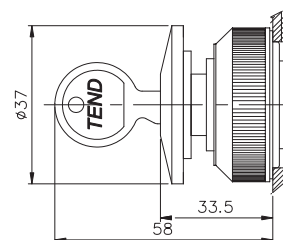

T2KLS

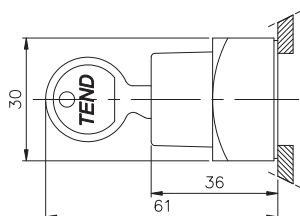
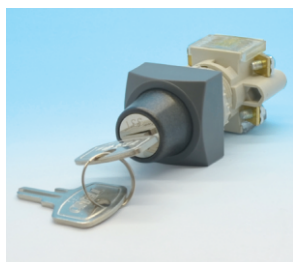

T2KMS

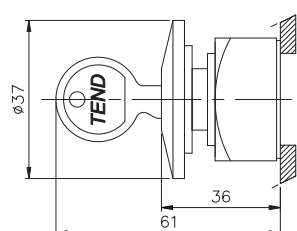
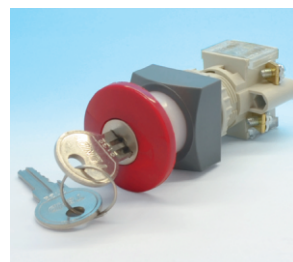

本系列開關盒固定孔徑為Ø22mm/Ø30mm二種，單孔開關盒有黃、灰二色，其餘全為灰色，其上座部份及接點座皆為專用型式，不同於Ø22/Ø30系列控制器材。

上座部份之裝配尺寸、種類則與Ø22/Ø30系列控制器材相同，其型式代號為Ø22/Ø30系列控制器材之型式代號後面加B，例：Ø22平頭圓型按鈕上座，控制器材型式為T2BFR，開關盒專用上座為T2BFR-B。

開關盒與開關之組立

- ① 將開關盒上蓋與下座拆開。
 - ② 將接點座固定於開關盒下座，將上座固定於開關盒上蓋。
 - ③ 將開關盒之上蓋與下座組合鎖上即成整組。
- 本系列開關盒保護構造為IP65(IEC144)
 - 用於開關盒上之所有照光式開關，一律為直接式。

開關盒標準接點座 (接點圖同標準接點座,TA54頁)

TC-B1A.TC-B1B.TC-B1C
TC-B2A.TC-B2B

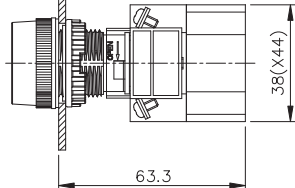

TC-B2C

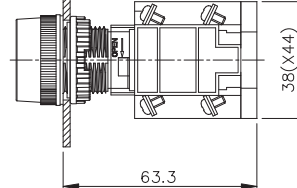

開關盒照光式接點座 (接點圖同直接式照光接點座,見TA59頁)

TC-BI1A.TC-BI1B

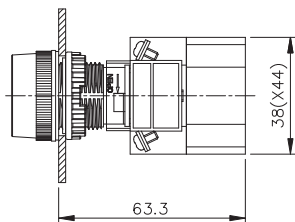
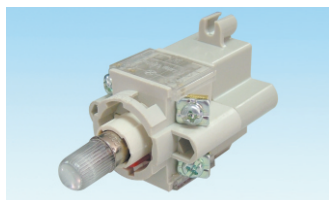

TC-BI1C.TC-BI2A

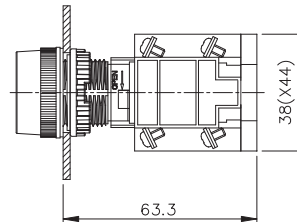

開關盒指示燈電源座 (接線圖同直接式指示燈,見TA67頁)

TPS-3

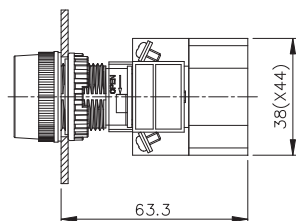

開關盒外觀與尺寸 (Ø22與Ø30系列,除固定孔徑不同外,其餘尺寸皆相同)

TN2-B1



TN2-B2



TN2-B3



TN2-B4



TN2-B5

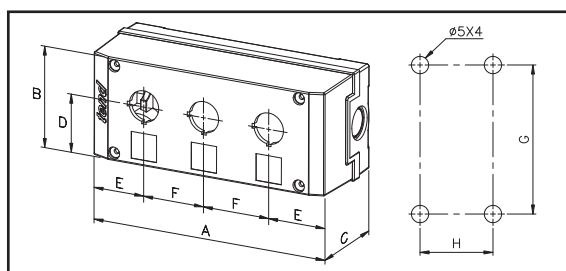

型 式	A	B	C	D	E	F	G	H
TN2-B1 TN3-B1	82	75	67.3	43.5	41	—	63	54
TN2-B2 TN3-B2	127	75	67.3	43.5	41	45	108	54
TN2-B3 TN3-B3	172	75	67.3	43.5	41	45	153	54
TN2-B4 TN3-B4	217	75	67.3	43.5	41	45	198	54
TN2-B5 TN3-B5	262	75	67.3	43.5	41	45	243	54

- 本系列開關盒附開關裝配孔徑為Ø22一種,其裝配之照光式、指示燈全為直接式。
- 所有開關之接點,全部為1A1B,外形為圓形。
- 大頭按鈕、連鎖式按鈕之開關盒為黃色及灰色,其餘為灰色。

一個開關 型號說明

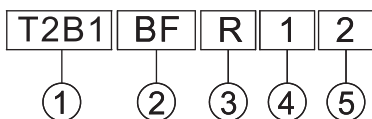

項次	代號	說明
1. 開關數	T2B1	一個開關
2. 型式	BF	平頭按鈕
	BL	凸頭按鈕
	BM	大頭按鈕
	BK	連鎖式按鈕
	KM	鑰匙連鎖式大頭按鈕
	IF	平頭照光按鈕
	IL	凸頭照光按鈕
	IM	大頭照光按鈕
	IK	照光式連鎖按鈕
	S2	二段式選擇
S3	三段式選擇	

項次	代號	說明
3. 顏色	R G B	紅色 綠色 黑色
4. 銘牌	1	OFF
	2	ON
	3	EM.STOP
	4	OFF-ON
	5	ON-OFF-ON
5. 電壓	空白 2 7	非照光式 220 VAC 24 V

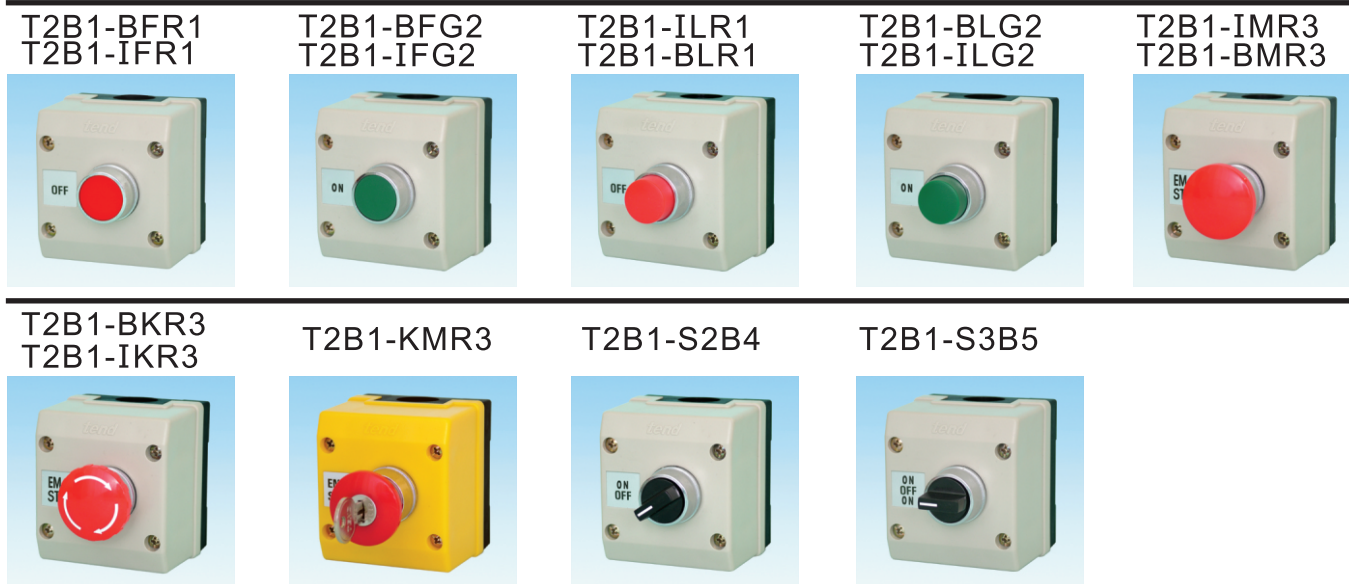

二個開關



型式	銘牌	開關種類	電壓
T2B2-BF	(上) ON(下) OFF	平頭按鈕(上)綠(下)紅	
T2B2-IF2	(上) ON(下) OFF	平頭照光按鈕(上)綠(下)紅	220 VAC
T2B2-IF7	(上) ON(下) OFF	平頭照光按鈕(上)綠(下)紅	24 V

三個開關



型式	銘牌	開關種類
T2B3-BF	(上) ON(中) OFF(下) ON	平頭按鈕(上)綠(中)紅(下)綠
T2B3-IF	(上) ON(中) OFF(下) ON	平頭照光按鈕(上)綠(中)紅(下)綠
T2B3-PF2	(上) 220V(中) ON(下) OFF	(上) 指示燈紅色(中) 平頭按鈕綠色(下) 平頭按鈕紅色
T2B3-PF7	(上) 24V(中) ON(下) OFF	(上) 指示燈紅色(中) 平頭按鈕綠色(下) 平頭按鈕紅色

■ 附件

TN2-GR
圓形護蓋

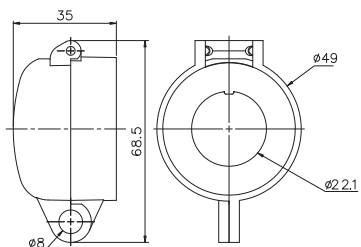

TN3-GR
圓形護蓋

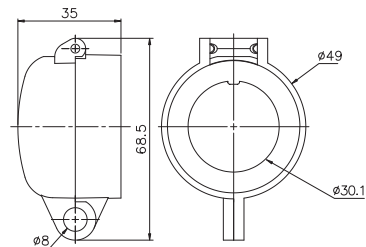

Ø22/Ø25/Ø30標示貼紙

■ 開關盒專用背膠貼紙

TBP、TBM

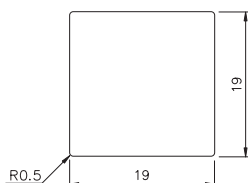

TN2-EA (連鎖式護座無印字)
TN2-EB (連鎖式護座)

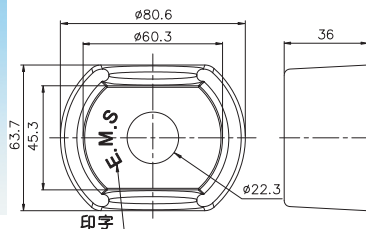

● 按鈕及照光式按鈕、指示燈用

TBP-01	TBP-02	TBP-03	TBP-04	TBP-05	TBP-06	TBP-07	TBP-08	TBP-09	TBP-10	TBP-11	TBP-12	TBP-13	TBP-14	TBP-15
○	I	II	III	IV	ON	OFF	START	STOP	UP	DOWN	SOURCE	HAND	AUTO	RUN
TBP-16	TBP-17	TBP-18	TBP-19	TBP-20	TBP-21	TBP-22	TBP-23	TBP-24	TBP-25	TBP-26	TBP-27	TBP-28	TBP-29	TBP-30
FWD	REV	CLOSE	OPEN	FAST	SLOW	RESET	EM.STOP	12V	24V	30V	110V	220V	B	1
TBP-31	TBP-32	TBP-33	TBP-34	TBP-35	TBP-36	TBP-37	TBP-38	TBP-39	TBP-40	TBP-41	TBP-42	TBP-43	TBM-01	TBM-02
2	3	4	5	6	7	8	9	INCH	➔	B1	B2		開	關
TBM-03	TBM-04	TBM-05	TBM-06	TBM-07	TBM-08	TBM-09	TBM-10	TBM-11	TBM-12	TBM-13	TBM-14	TBM-15	TBM-16	TBM-17
啓動	停止	電源	手動	自動	寸動	運轉	正轉	逆轉	高	低	快速	慢速	連鎖	上
TBM-18	TBM-19	TBM-20	TBM-21	TBM-22										
下	左	右	緊急	超載										

● 選擇開關用

TBP-51	TBP-52	TBP-53	TBP-54	TBP-55	TBP-56	TBP-57	TBP-58	TBP-59	TBP-60	TBP-61	TBP-62	TBP-63	TBP-64	TBP-65
○	II	III	IV	ON OFF	ON ON	ON OFF ON	REV FWD	REV OFF FWD	AUTO HAND	AUTO OFF HAND	START STOP	UP DOWN	UP OFF DOWN	1 2
TBP-66	TBP-67	TBP-68	TBP-69	TBP-70	TBP-71	TBP-72	TBP-73	TBP-74	TBP-75	TBP-76	TBP-77	TBM-31	TBM-32	TBM-33
1 0 2	1 2 3	OFF ON	ON ON	ON OFF ON	STOP START	UP DOWN	UP OFF DOWN	AUTO HAND	AUTO OFF HAND	FR WE WD VD	OR FE FV	手動 自動	手動 停止 自動	正轉 逆轉
TBM-34	TBM-35	TBM-36	TBM-37	TBM-38	TBM-39	TBM-40	TBM-41	TBM-42	TBM-43	TBM-44	TBM-45	TBM-46		
正轉 停止 逆轉	運轉 停止	上 下	上 停 下	開 關	啓動 停止	停止 啓動	上下	上 停 下	手動 自動	手動 停止 自動	正轉 逆轉	正轉 停止 逆轉		

■ Ø22/Ø25/Ø30系列控制器材警示牌

警示牌 (黃色)

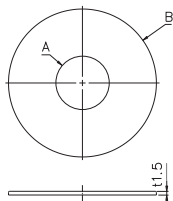

料號	品名	A	B
TN22E-01	22小警示牌	Ø22	Ø60
TN25E-01	25小警示牌	Ø25	Ø60
TN30E-01	30小警示牌	Ø30	Ø60
TN22EL-01	22大警示牌	Ø22	Ø90
TN25EL-01	25大警示牌	Ø25	Ø90
TN30EL-01	30大警示牌	Ø30	Ø90

警示牌 (STOP) (黃色黑字)

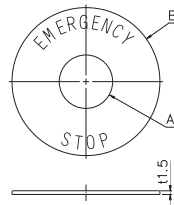

料號	品名	A	B
TN22E-02	22小警示牌(STOP)	Ø22	Ø60
TN25E-02	25小警示牌(STOP)	Ø25	Ø60
TN30E-02	30小警示牌(STOP)	Ø30	Ø60
TN22EL-02	22大警示牌(STOP)	Ø22	Ø90
TN25EL-02	25大警示牌(STOP)	Ø25	Ø90
TN30EL-02	30大警示牌(STOP)	Ø30	Ø90

■ Ø22/Ø25/Ø30系列控制器材壓克力銘牌 (P) 及鋁銘牌 (M)

TN22P- (22塑膠銘牌) TN22M- (22鋁銘牌)
 TN25P- (25塑膠銘牌) TN25M- (25鋁銘牌)
 TN30P- (30塑膠銘牌) TN30M- (30鋁銘牌)

尺寸	A	B	C	D
TN22P	Ø22.3	41	32	52.5
TN22M	Ø22.2	31	27	42
TN25P	Ø25.5	41	32	52.5
TN25M	Ø24.9	31	27	42
TN30P	Ø30.5	41	32	52.5
TN30M	Ø30.3	38.5	32.5	52

01	02	03	04	05	06	07	08	09	10	11	12					
ON	OFF	START	STOP	UP	DOWN	SOURCE	MUNUEL	AUTO	RUN	FWD	REV					
13	14	15	16	17	18	19										
OFF	ON	ON	ON	ON	OFF	ON	FWD	REV	FWD	OFF	REV	AUTO	MANU	AUTO	OFF	MANU
20	21	22														
STOP	START	MANU	OFF	AUTO	1	0										
31	32	33	34	35	36	37	38	39								
開	關	啓動	停止	電源	手動	自動	寸動	運轉								
40	41	42	43													
手動	自動	手動	停止	自動	逆轉	正轉	逆轉	停止	正轉							
51	52	53	54	55	56	57	58	59								
开	关	启动	停止	电源	手动	自动	寸动	运转								
60	61	62	63													
手动	自动	手动	停止	自动	逆转	正转	逆转	停止	正转							
71	72	73	74													
○					○											

■ Ø22/Ø25/Ø30按鈕、照光按鈕用透明銘牌

TPP、TPM

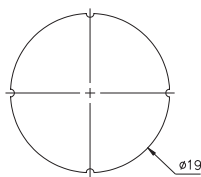

TPP-01	TPP-02	TPP-03	TPP-04	TPP-05	TPP-06	TPP-07	TPP-08	TPP-09	TPP-10	TPP-11
○					ON	OFF	START	STOP	UP	DOWN
TPP-12	TPP-13	TPP-14	TPP-15	TPP-16	TPP-17	TPP-18	TPP-19	TPP-20	TPP-21	TPP-22
SOURCE	HAND	AUTO	RUN	FWD	REV	CLOSE	OPEN	FAST	SLOW	RESET
TPP-23	TPP-24	TPP-25	TPP-26	TPP-27	TPP-28	TPP-29	TPP-30	TPP-31	TPP-32	TPP-33
INCH	12V	24V	30V	110V	220V	B	1	2	3	4
TPP-34	TPP-35	TPP-36	TPP-37	TPP-38	TPP-39	TPP-40	TPP-41	TPP-42	TPP-43	
5	6	7	8	9	→	B1	B2	B3	B4	
TPM-01	TPM-02	TPM-03	TPM-04	TPM-05	TPM-06	TPM-07	TPM-08	TPM-09	TPM-10	TPM-11
開	關	啓動	停止	電源	手動	自動	寸動	運轉	正轉	逆轉
TPM-12	TPM-13	TPM-14	TPM-15	TPM-16	TPM-17	TPM-18	TPM-19	TPM-20	TPM-21	TPM-22
高	低	快速	慢速	連鎖	上	下	左	右	緊急	超載